



rosco
VISION

SAFE-T-SCOPE®

BACKUP CAMERA SYSTEMS



STSM244
7" WINDSHIELD MIRROR MONITOR
INSTALLATION/USER MANUAL

TABLE OF CONTENTS

Introduction	2
Component List and Description	3
Monitor Installation and Wiring Instructions.	4
Wiring Diagram	5
Camera Installation	6
Monitor Functions and Operations	7
Monitor Settings and Menus	8-10
Technical Specifications and Notes	11

STSM244 SAFE-T-SCOPE® 7" WINDSHIELD MIRROR MONITOR

Rosco Vision Systems introduces a camera system for commercial vehicles. The new Safe-T-Scope® STSM244 utilizes a windshield-mounted mirror. It is integrated with a 7" LCD monitor to display the rear-view image when the vehicle shifts into reverse. Additional inputs for other cameras are also featured. The 7" wide-angle monitor allows the driver to see obstructions behind the vehicle. In addition, the monitor brightness automatically adjusts between day and night modes. The STSM244 complies with FCC (USA) guidelines.

The STSM244 monitor has the capability for use with three cameras. Contact your Rosco dealer to discuss camera purchasing options.

NOTE

- Please read this manual carefully before using the product.
- This system is intended as an aid to safe driving operation.
- Drivers must always use extreme caution when operating a vehicle.
- Specifications subject to change without prior notice.
- Keep all cables AWAY from rotating and electrically noisy components.
- Make sure all cables are fastened properly to prevent wire chafing, kinks, cuts, etc.



WARNING

- To prevent electrical shock, DO NOT OPEN MONITOR CASE.
- Avoid exposing monitor to water, rain, moisture etc.
- Do not disassemble the monitor. This voids the warranty.

COMPONENT LIST AND DESCRIPTION - STSM244

STSM244MO



7" LCD Monitor

STSM244PHAR



Power harness - 13-pin connector,
3 channel, 4-pin inputs

STSD1003



STSM244 Mounting kit

MONITOR INSTALLATION

The STSM244 7" Windshield Mirror Monitor is designed to attach to the windshield button of the vehicle. An additional windshield button is included with the STSM244. Attach the supplied mount to the monitor with the 4 supplied screws. Torque screws by hand to 7 in-lbs. The standard mount, STSDF1003, is compatible with many common vehicle models. Please contact your Rosco dealer for alternative mounting options.

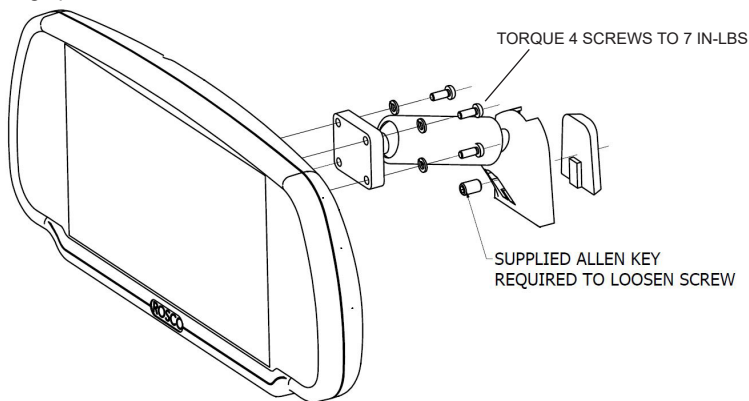

Fig. A

WIRING INSTRUCTIONS

- Once the monitor is mounted, if necessary, drill a 1" diameter hole near the monitor through which to pass the monitor cable and 13-pin connector. Clear any obstacles before drilling holes.
- Connect the black wire from the power harness to chassis ground. Connect the red wire to an ignition switched accessory (ex. radio) power source and ensure that the power source can provide operating current above 2 Amps.
- Connect the blue trigger wire to the vehicle's reverse signal circuit. DO NOT connect trigger to any constant power source. Trigger wires can be connected to the vehicle's left & right turn signal circuit to get the view of the blind spot while turning left/right. See wiring diagram on the opposite page.
- Connect a rear camera to C3 Rear. Left and right cameras can also be connected. See wiring diagram on the opposite page.
- Connect the monitor's 13-pin connector to the power harness' 13-pin connector. Make sure the arrows on both connectors are aligned and pointing towards each other.
- All connections should be completely hidden from the vehicle operators. The harness should be tied/clamped to a rigid structure or rigid existing vehicle harness.
- Adhere to a 2 inch bend radius for all cables to prevent damage.

FUEL TANKERS & OTHER SPECIALTY VEHICLES:

- All electrical equipment fitted to petroleum vehicles must be connected via battery master switch. The electrical equipment must be isolated from the battery while the vehicles are loading and unloading. For other specialty vehicles, please check applicable codes and regulations prior to installation.
- Consult your dealer when adding any electrical or electronic equipment to a vehicle fitted with a CAN-bus multiplex system.

WIRING DIAGRAM

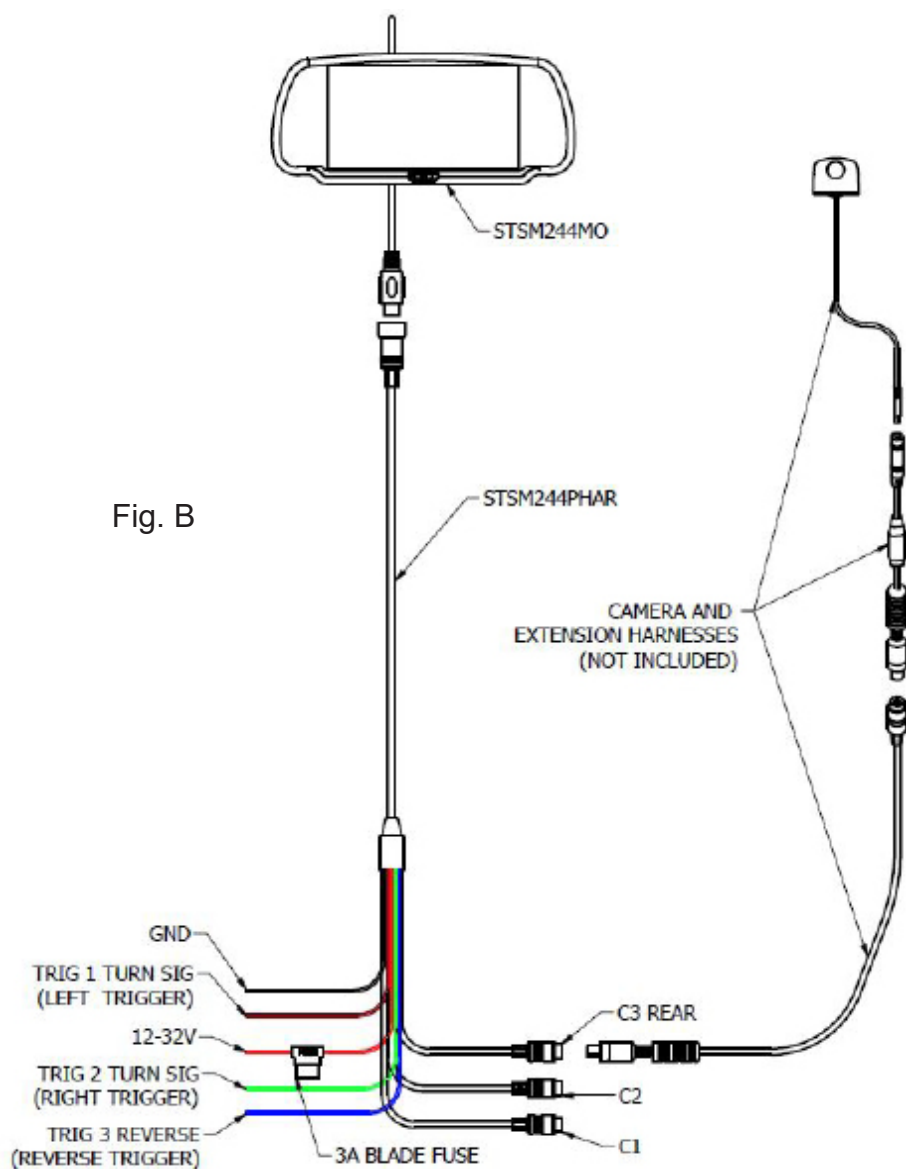

For camera options, contact your Rosco dealer.

CAMERA INSTALLATION

EXAMPLE CAMERA INSTALLATION

(Camera not included with monitor)

1. Select a high and centered location at the rear of the vehicle to mount the camera.

IMPORTANT: When selecting this location it is highly recommended that the image transmitted by the camera shows the rear bumper and area behind the vehicle.

2. Mounting the camera near the lower area of the vehicle (ex. bumper) is not recommended. This reduces the view of the camera and increases the chance of physical damage to the camera.

3. Once the location for the camera is chosen, drill the mounting hole to the inside of the vehicle using an applicable drill bit. Clear any obstacles before drilling the hole.

4. Attach the provided 3M double-sided tape to the back of the camera, if applicable.

5. Insert camera wire through the newly drilled hole, mount the camera securely in place.

Fig. C

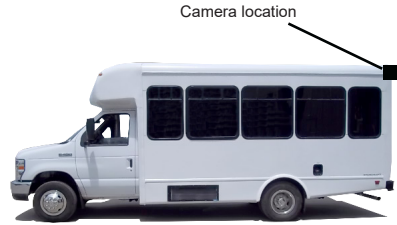

Mount the camera high and centered on the rear of the vehicle.



Obstructions behind truck

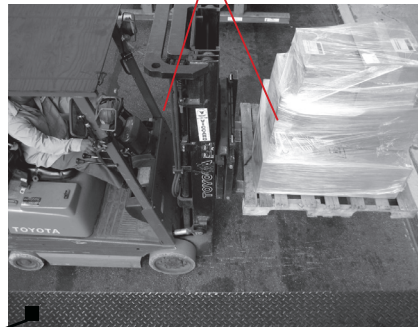

Vehicle bumper

Typical view of a properly installed camera.

MONITOR FUNCTIONS AND OPERATIONS

i IMPORTANT: It is recommended that the menu buttons only be operated when the vehicle is in park or neutral.

1. & 3. ^ / v VOLUME/MENU SETTING ADJUST BUTTONS

Decrease/Increase audio volume when no menu is open.

Use these buttons to sort through the menu tabs when no menu parameter is highlighted.

Decrease/increase the value for a particular menu parameter.

2. MENU SETTING AND PAGE TOGGLE

Brings up the monitor settings menu. Press the button again to scroll through the various settings on a menu page and to access the camera settings menu page (see following page).

4. SELECT BUTTON

Scroll through camera channels. If no camera is connected, the display will be blue.

5. POWER ON/OFF

Turns the LCD on or off. The default state of the LCD is OFF when power is connected. The monitor will display any triggered input regardless of LCD power status.

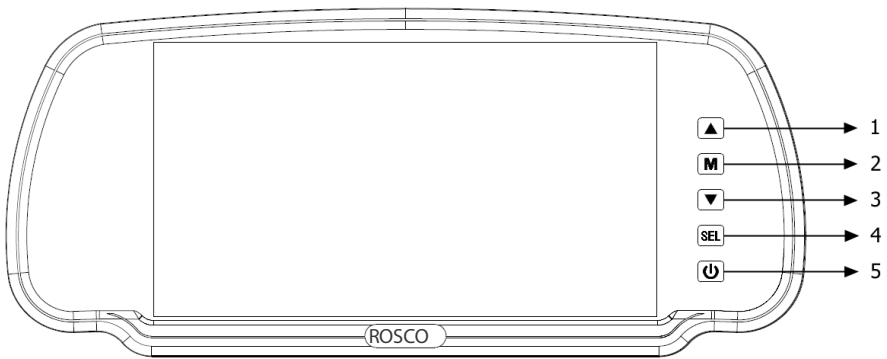

Fig. D

MONITOR SETTINGS AND MENU

i NOTE: Press the **M** button to enter the menu and the **▲** or **▼** button to change pages.

MENU SETTINGS PAGE 1: PICTURE

Press the **M** button (see preceding page) to access this menu. Press **M** again to scroll through the lists of parameters. At an individual parameter (text will turn red when selected), press **▲** or **▼** to adjust the settings of each parameter.

Parameter	Options
BRIGHT	1~100. Default Auto, Daytime, and Nighttime = 50.
CONTRAST	1~100. Default Auto and Daytime = 50, Nighttime = 45.
COLOR	1~100. Default = 50.
VOLUME	1~100. Default = 50.
TINT ¹	1~100. Default = 50.
RESET	Resets all settings back to factory default

DAY MODE / NIGHT MODE denotes whether the monitor is applying daytime brightness or night-time brightness, depending on the light sensor or the AUTO DIM setting in the OPTION menu page.

1. TINT only appears when the monitor is receiving a signal from the camera.

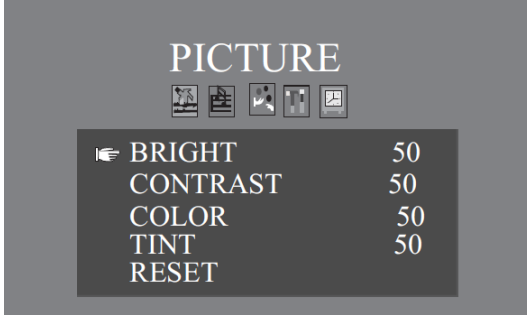

MENU SETTINGS PAGE 2: VOLUME

This menu allows the user to adjust the audio from the camera.

Parameter	Options
VOLUME	1~100. Default = 50.

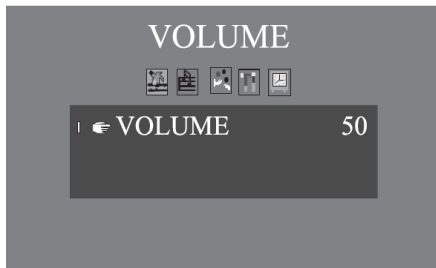

MONITOR SETTINGS AND MENU

i NOTE: Press the **M** button to enter the menu and the **▲** or **▼** button to change pages.

MENU SETTINGS PAGE 3: OPTION

This menu allows the user to adjust the language, mirroring of the camera, aspect ratios, and the automatic dimming of the monitor.

Parameter	Options
LANG	English, Dutch, French, Spanish, Portuguese, or Italian. Default = English.
CAM1	Normal or Mirror. Default = Normal.
CAM2	Normal or Mirror. Default = Normal.
CAM3	Normal or Mirror. Default = Normal.
ZOOM	16:9 or 4:3. Default = 16:9.
AUTO DIM ¹	Auto, Day, Night, or Off. Default = Auto.
<p>This monitor is built for use as a backup system and the default setting Normal displays a conventional backup camera image. Setting MIRROR would un-mirror the image. It is suggested to leave default on NORMAL.</p>	

1. When altering picture in day/night mode, those values are saved for day/night mode until reset.

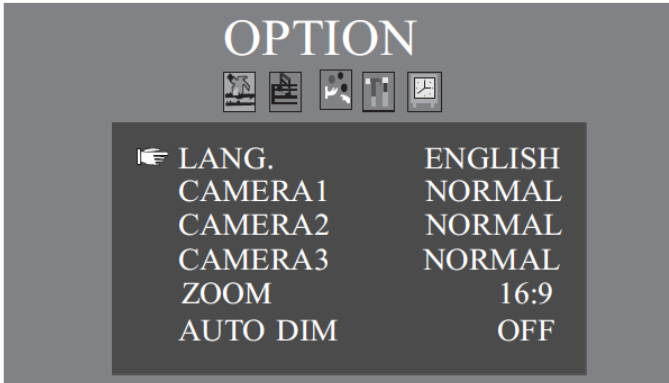

MONITOR SETTINGS AND MENU

i NOTE: Press the **M** button to enter the menu and the **▲** or **▼** button to change pages.

MENU SETTINGS PAGE 4: SYSTEM

This menu allows the user to alter color of image, set a shut-off delay, and add parking guidelines. ACC1, 2, and 3-Time delay shut-off of the monitor when power to the corresponding trigger is cut. GUIDE LINE adds parking guidelines to the monitor to give perspective on the objects behind the vehicle.

Parameter	Options
S-COLOR ¹	Auto, NTSC, or PAL. Default = Auto.
ACC1, 2, and 3-TIME	0~15 seconds. Default = 1 second.
GUIDE LINE ²	On or Off. Default = Off. Only available when reverse trigger wire is activated.
ACC-TIME only works when the trigger is turned off, not the monitor.	

1. Rosco cameras are formatted for NTSC. It is recommended to leave parameters as is.
2. The guideline parameter only appears on Camera 3 (Camera 3 - Rear, trigger 3) and if the monitor is reset, the guidelines are removed.

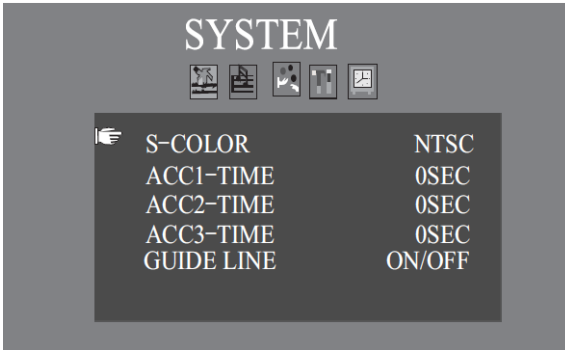

STSM244 TECHNICAL SPECIFICATIONS

PARAMETER	VALUE
Screen Size (Diagonal)	7"
Dimensions (L x W x T)	10" x 4.3" x 1.2"
TV System	CVBS - NTSC
Video Inputs	3 Inputs
Audio Inputs	3, audio on all channels
Input Format	4-pin
Trigger Inputs	3
Resolution	800 x 480 pixels
Brightness	1000 cd/m ²
Contrast	450:1
Voltage	DC 12V~24V
Maximum Current Consumption	1,000mA
Viewing Angles Up/Down/Left/Right	60° x 60° x 75° x 75°
Shock Rating	2G
Vibration Rating	6G
Operating Temperature	-4°F to 158°F (-20°C to 70°C)
Storage Temperature	-22°F to 176°F (-30°C to 80°C)

NOTES



rosco
VISION

A CENTURY OF AUTOMOTIVE VISION SAFETY

90-21 144th Place, Jamaica, New York 11435

Tel. - (718) 526-2601 • Toll Free - (800) 227-2095

techsupport@roscovision.com

www.roscovision.com